

# DOMINATOR<sup>®</sup>

---

## INSTALLATION GUIDE

---

72" ADJUSTABLE HOOP

MODEL #: 724-AA



- SECTION 1:** Safety Instructions
- SECTION 2:** Hoop Specifications
- SECTION 3:** Bolt Plate Installation
- SECTION 4:** Hoop Installation
- SECTION 5:** Warranties & Policies

# SECTION 1: SAFETY INSTRUCTIONS



## SAFETY INSTRUCTIONS



FAILURE TO FOLLOW THESE SAFETY INSTRUCTIONS MAY RESULT IN SERIOUS INJURY OR PROPERTY DAMAGE AND WILL VOID WARRANTY.

*Owner must ensure that all players know and follow these rules for safe operation of the system.*

To ensure safety, do not attempt to assemble this system without following the instructions carefully. Check the entire box and inside all packing material for parts and/or additional instruction material. Before beginning assembly, read the instructions and identify parts using the hardware identifier and parts list in the instructions. Proper and complete assembly, use, and supervision are essential for proper operation and to reduce the risk of accident or injury. A high probability of serious injury exists if this system is not installed, maintained, and operated properly.

- If using a ladder during assembly, use extreme caution.
- 3 capable adults are recommended for this operation.
- Assemble the base properly. Failure to do so could cause the base to separate during play.
- Before digging, contact utility company to locate underground power cables, gas, and water lines. Ensure that there are no overhead power lines within 20 ft. (7m) radius of pole location.
- Minimum operational height is 6'6" (1.98 m) to the bottom of the backboard.

*Most injuries are caused by misuse and/or not following instructions. Use caution when using this system.*



## WARNING



FAILURE TO FOLLOW THESE WARNINGS MAY RESULT IN SERIOUS INJURY AND/OR PROPERTY DAMAGE

- Do not hang from the rim.
- During play, especially when performing dunk type activities, keep players face away from the backboard, rim and net. Serious injury could occur if teeth/face come in contact with backboard, rim, or net.
- Do not slide, climb, or play on pole.
- When adjusting height or moving system, keep hands and fingers away from moving parts.
- During play, do not wear jewelry (rings, watches, necklaces, etc.). Objects may entangle in net.
- Check system before each use for loose hardware and instability. Repair before each use. Never play on damaged equipment.

**DOMINATOR**

801.769.4663



**Know what's below.  
Call before you dig.  
1-888-258-0808**

**BEFORE** digging for the Bolt Plate installation, contact your local call-before-you-dig phone number so you don't unintentionally dig into an underground utility line.

\*Save this instruction sheet in the event that the manufacturer has to be contacted for replacement parts.

# SECTION 2: HOOP SPECIFICATIONS

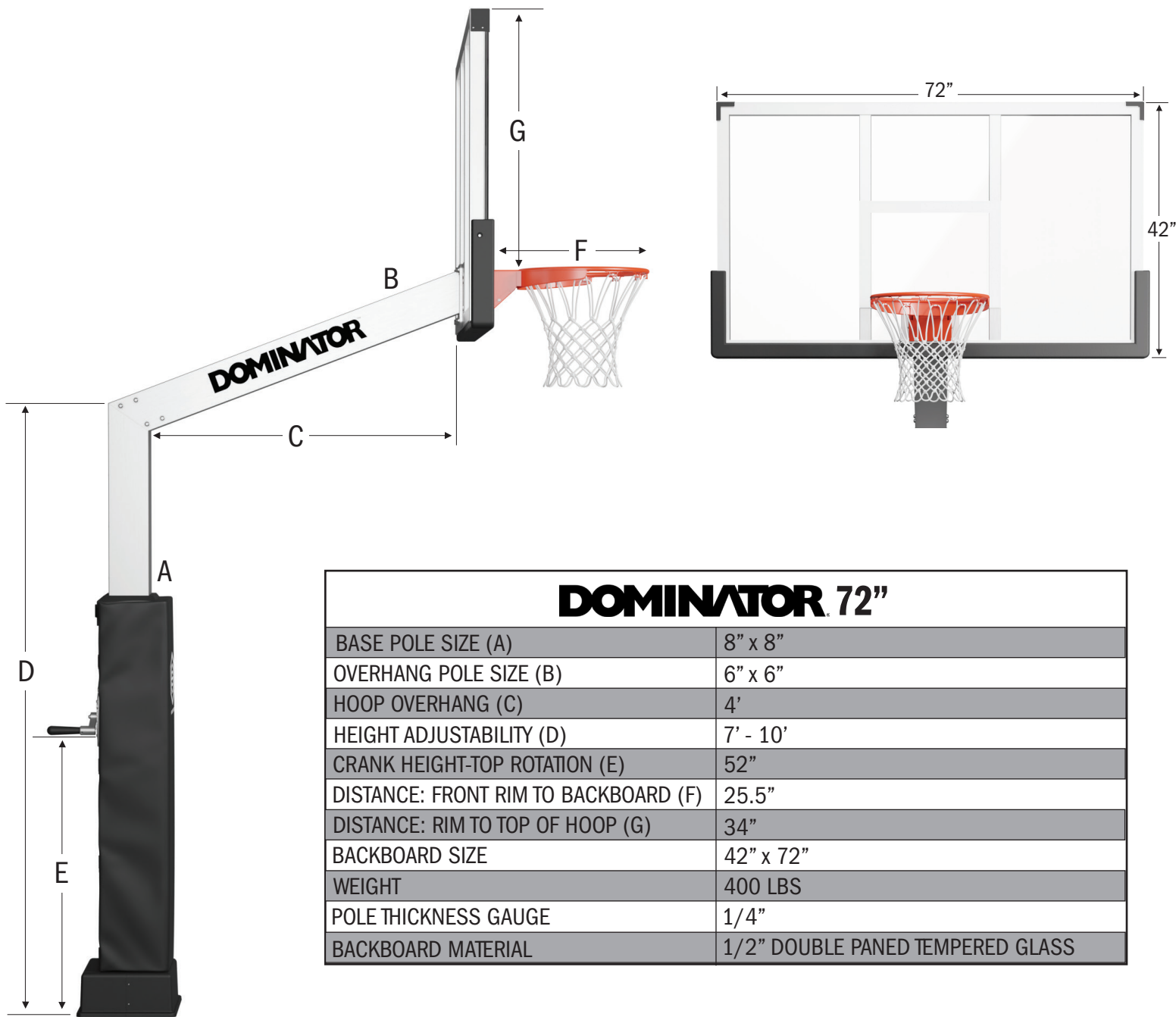

<b>DOMINATOR 72"</b>	
BASE POLE SIZE (A)	8" x 8"
OVERHANG POLE SIZE (B)	6" x 6"
HOOP OVERHANG (C)	4'
HEIGHT ADJUSTABILITY (D)	7' - 10'
CRANK HEIGHT-TOP ROTATION (E)	52"
DISTANCE: FRONT RIM TO BACKBOARD (F)	25.5"
DISTANCE: RIM TO TOP OF HOOP (G)	34"
BACKBOARD SIZE	42" x 72"
WEIGHT	400 LBS
POLE THICKNESS GAUGE	1/4"
BACKBOARD MATERIAL	1/2" DOUBLE PANED TEMPERED GLASS

## WHERE SHOULD I INSTALL MY HOOP?

A few questions to consider as you determine where to install your 72" Dominator Hoop:

- Are there any utility lines below the surface of the chosen location? (See Section 1: Safety Instructions)
- When raised to the very top (10'), will the backboard obstruct anything?
- Do you have enough room behind the hoop to properly use the height crank?
- If installing on a driveway, is there adequate room for vehicles to pull in/out without hitting the rim/backboard?
- Keep in mind the time of day you like to use your hoop and where the sun will be at that time of day.
- Will you need extra lighting?
- What is your playing surface? Is it level ground or sloped?
- Are you going to be using court markings?

# SECTION 3: 10"x10" BOLT PLATE INSTALLATION

## DIMENSIONS

Hole Depth: 3'

Hole Length/Width: 2' x 2'

## PARTS USED

(1) Bolt Plate (Part C)

(4) J-Bolts (Part D)

(4) Rebar (Part H)

## TOOLS REQUIRED



Shovel



Tape Measure



Concrete



Level

## INSTRUCTIONS

**STEP 1:** Build a 2' x 2' frame out of 2" x 4" lumber & lay it on the ground where you want the hoop installed. See Figure 1.

**STEP 2:** Using a shovel, cut into the ground around the outside of the frame to give the hole a defined edge; remove frame. See Figure 1.

**STEP 3:** Remove the frame and dig a square hole to appropriate depth and dimensions shown in Figure 2.

**STEP 4:** Fill the hole half way with concrete and evenly space rebar in the dimensions shown in Figure 3. \*Note: Rebar is added to help reinforce & strengthen the concrete.

**STEP 5:** Continue filling hole with concrete until nearly full. Replace the frame and fill with cement until it is level with the playing surface. See Figure 4.

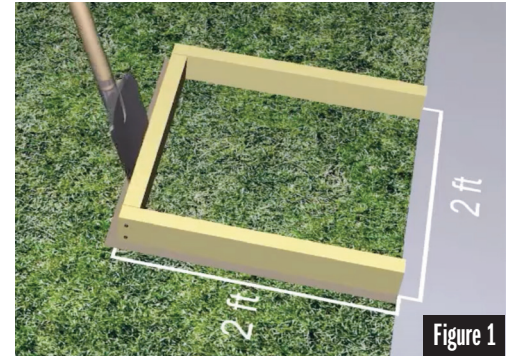

Figure 1

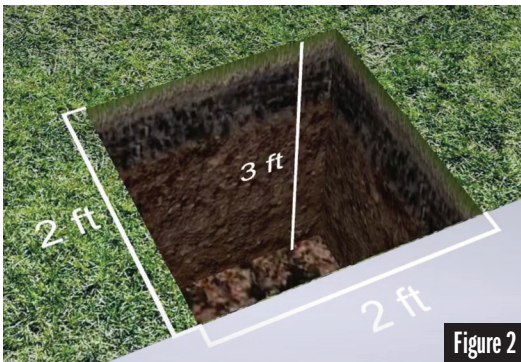

Figure 2

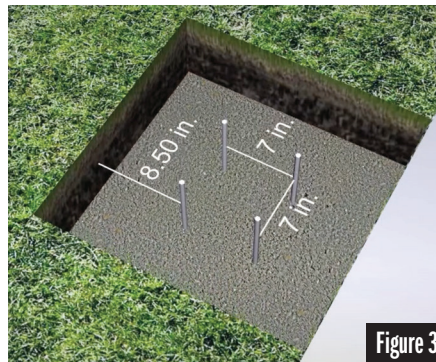

Figure 3

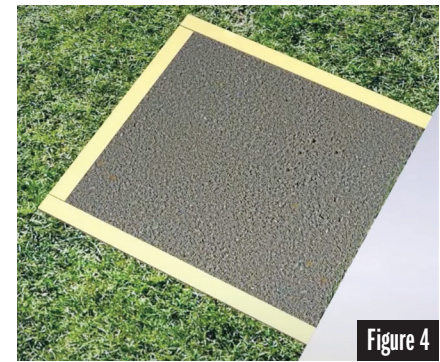

Figure 4

**STEP 6:**

- Assemble the bolt plate as shown in Figure 5.
- Set the bolt plate in the center of the 2' x 2' area parallel to the playing surface. See Figure 6.
- Measure the distance from the edge of the bolt plate to the edge of the frame to ensure it is centered. See Figure 7.

**STEP 7:** Make sure the bolt plate is level with the playing surface. See Figure 8. Let concrete dry 72 hours before removing frame & installing the hoop.

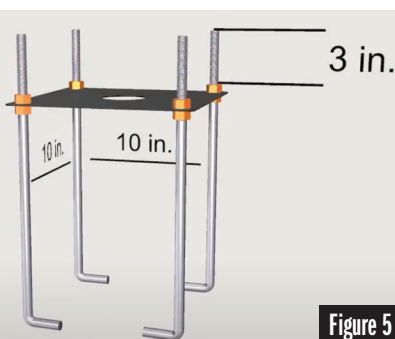

Figure 5

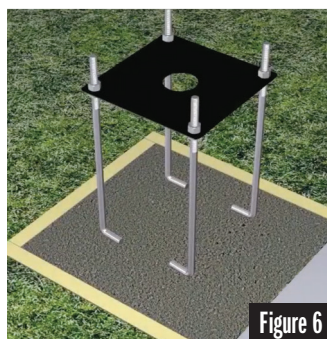

Figure 6

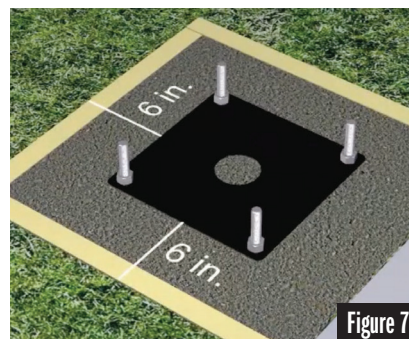

Figure 7

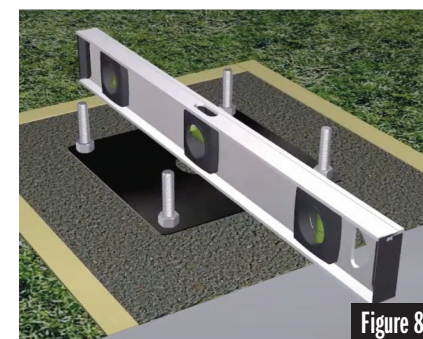
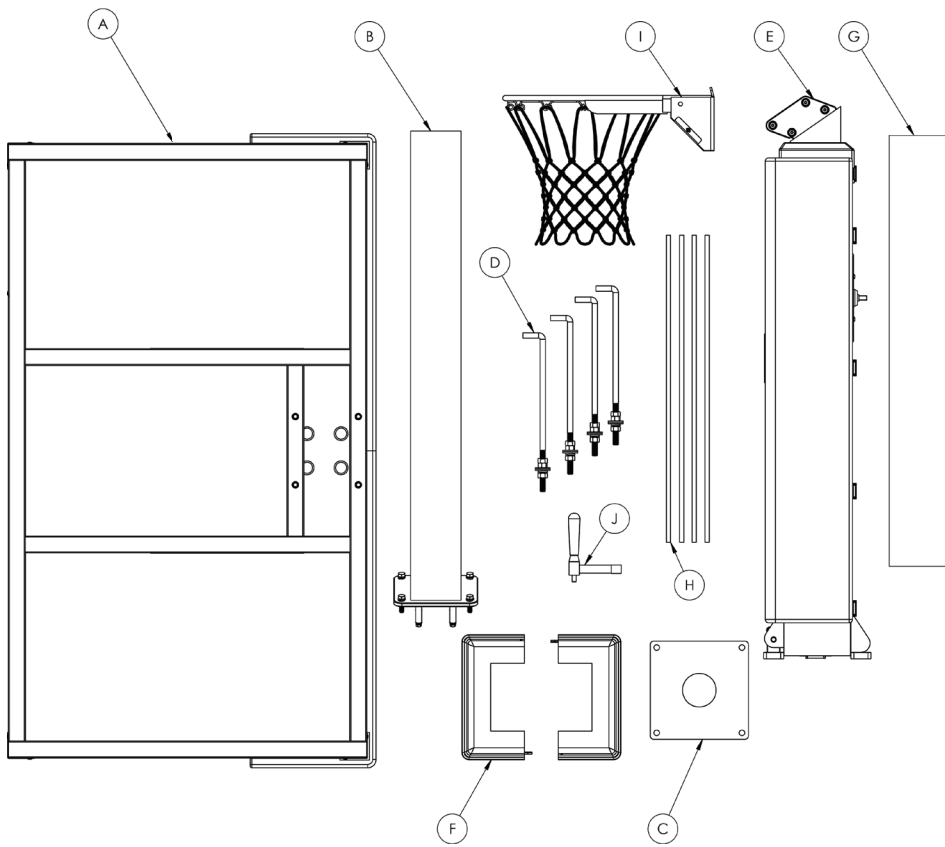





Figure 8

# SECTION 4: HOOP INSTALLATION

\*INSTALLATION REQUIRES 2-3 ADULTS MINIMUM. ENSURE BOLT PLATE & CONCRETE HAS HAD AT LEAST 72 HOURS TO SET.



## TOOLS REQUIRED

-  Phillips Head Screwdriver
-  Socket Wrench:  
9/16", 3/4", 13/16" sockets
-  Allen Wrench: 7/32" & 5/32"

ITEM #	PART #	PART DESCRIPTION	QTY
A	?	BACKBOARD	1
B	?	EXTENSION ARM	1
C	?	BASE PLATE	1
D	?	J-BOLT & HARDWARE	1
E	?	BASE POLE WITH PAD	1
F	?	BASE COVER	1
G	?	HEIGHT DECAL	1
H	?	REBAR	4
I	?	RIM WITH NET	1
J	?	CRANK HANDLE	1

## INSTRUCTIONS

**STEP 1:** Remove the Pad from the Base Pole (Part E). See Figure 1.

- STEP 2:**
- Place (4) Flat Washers on the J-Bolts of the anchor plate. See Figure 2.
  - Slide the Base Pole onto the J-Bolts with the round holes closest to the court & the slotted holes furthest away. Secure front, courtside bolts with (2) Flat Washers, (2) Lock Washers and (2) 5/8" Nuts. See Figure 3.
  - Hand tighten only.

- STEP 3:**
- Lay the Base Pole onto the court by using the pivot on the front. See Figure 4.
  - A few feet in front of the Base Pole, place the Backboard (Part A) on top of cardboard, a blanket or the provided foam (this will prevent the backboard from getting scratched). See Figure 5.

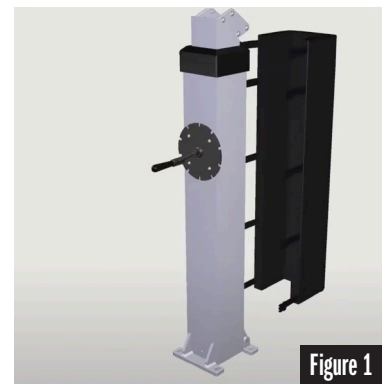

Figure 1

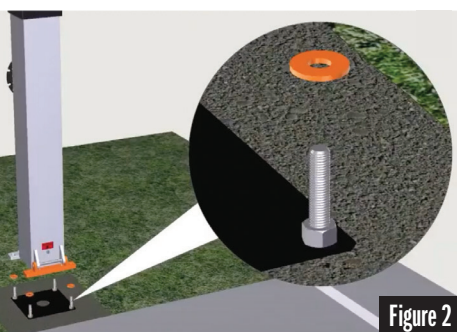

Figure 2

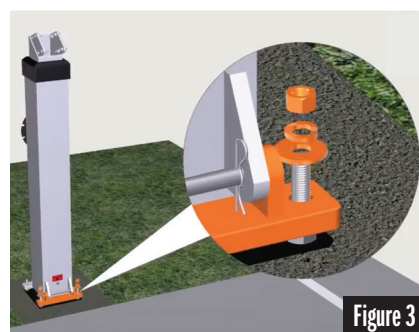

Figure 3

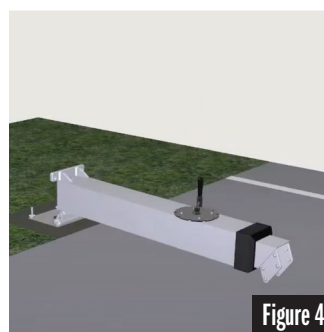

Figure 4

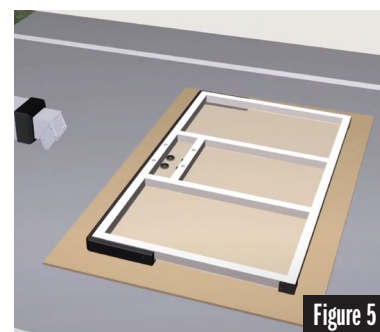
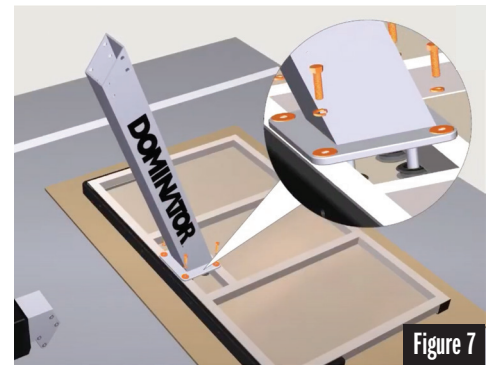
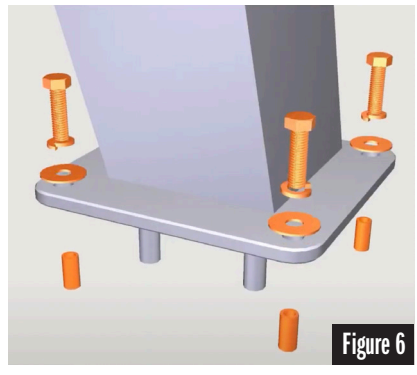

Figure 5

**STEP 4:**

- -Remove the hardware from the flat end of the Extension Arm (Part B) & discard tubes. See Figure 6.
- Align the Extension Arm with the Backboard and secure the hardware in the same order. See Figure 7.



**STEP 5:**

- Remove the hardware from the top end of the Base Pole. See Figure 8.
- Hold the Base Pole & the Extension Arm at a 45 degree angle. See Figure 9.
- Slide the Base Pole into the Extension Arm and secure the hardware in the same order. See Figure 10.

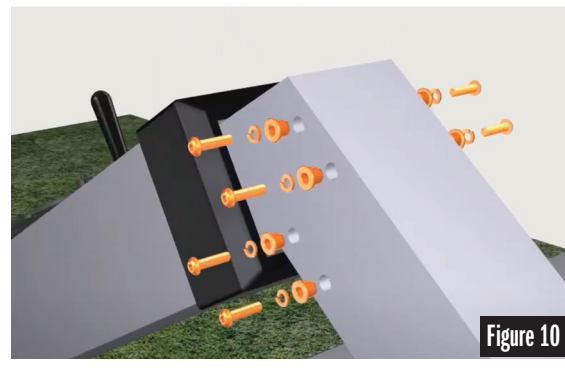
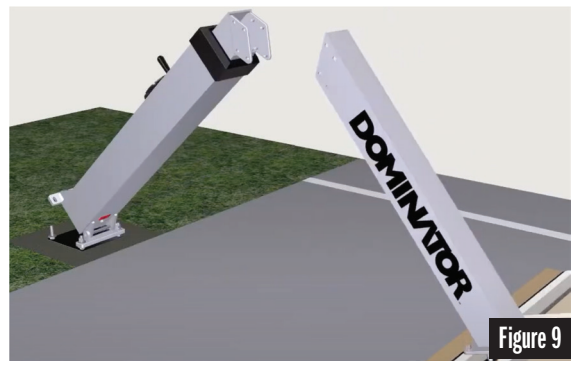
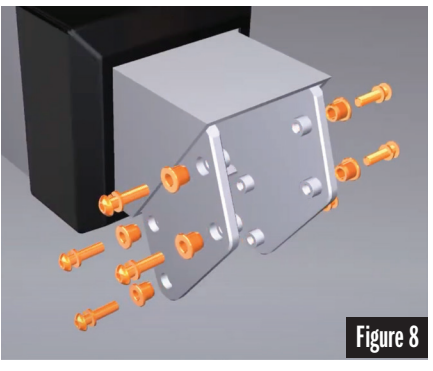

**STEP 6:**

- Raise the hoop until it is standing straight up. Hold the hoop in position for the following steps. See Figure 11.
- Secure remaining two bolts with (2) Flat Washers, (2) Lock Washers and (2) 5/8" Nuts. See Figure 12.
- Hand tighten only.



**STEP 7:**

- Adjust the lower base nuts to ensure the Base Pole is perfectly level. See Figure 13.
- Once level, tighten the top four nuts. \*This step requires two adults to stand up the hoop and one adult to secure the hardware.

**STEP 8:**

Once the system is upright and tightened, remove the Safety Bolt (marked with a red sticker) on the courtside of the Base Pole. See Figure 14. \*This must be done before moving onto the next step.

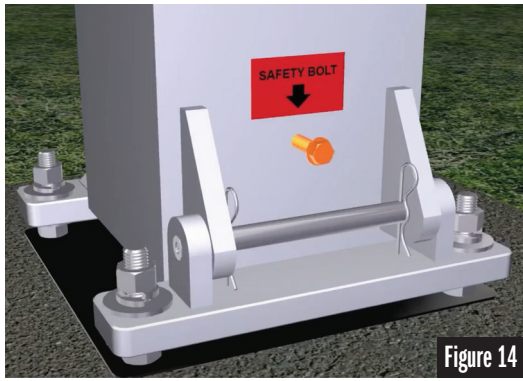
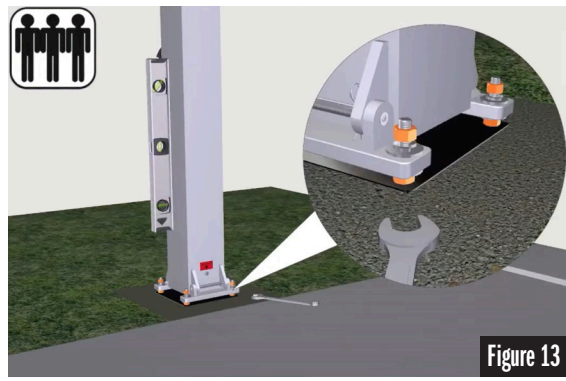
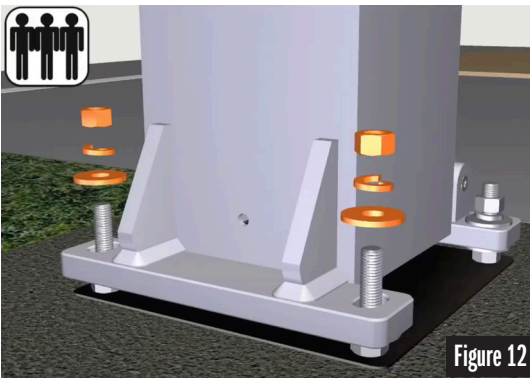

- STEP 9:**
- Remove the screws from the Base Cover (Part F). See Figure 15.
  - Encase the bottom of the Base Pole with the Base Cover and secure the two halves with the (4) screws. See Figure 16.

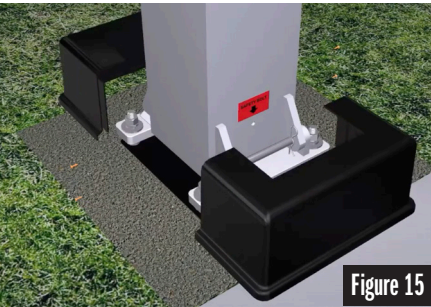

Figure 15

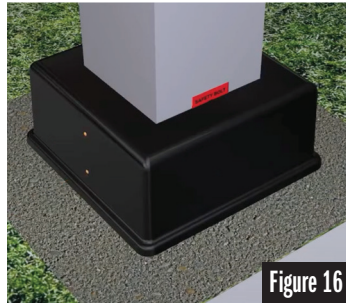

Figure 16

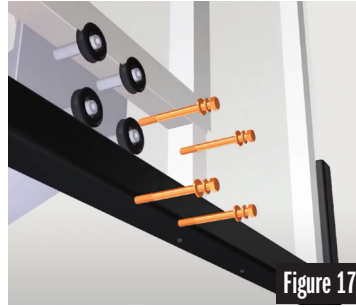

Figure 17

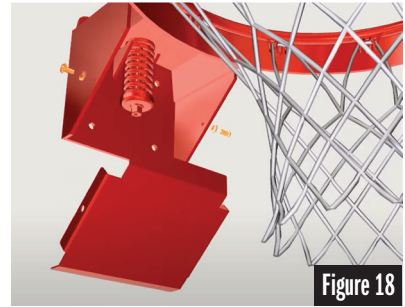

Figure 18

**STEP 10:** Remove hardware from the rim connection tubes on the Extension Arm. See Figure 17.

**STEP 11:** Remove the Rim Cover Plate from the underside of the Rim (Part I). See Figure 18.

**STEP 12:** Align the Rim on the Backboard and reinsert the hardware into the tubes and tighten. Replace the Cover on the Rim. See Figures 19 & 20.

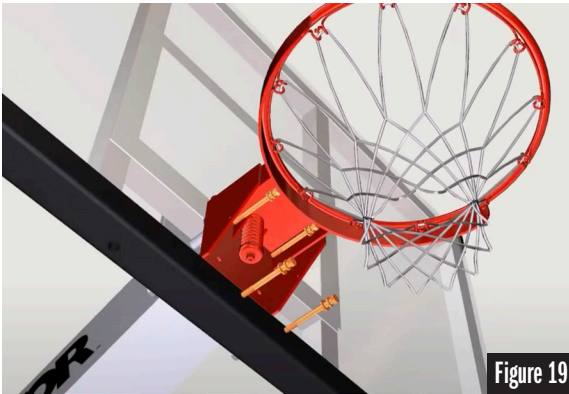

Figure 19

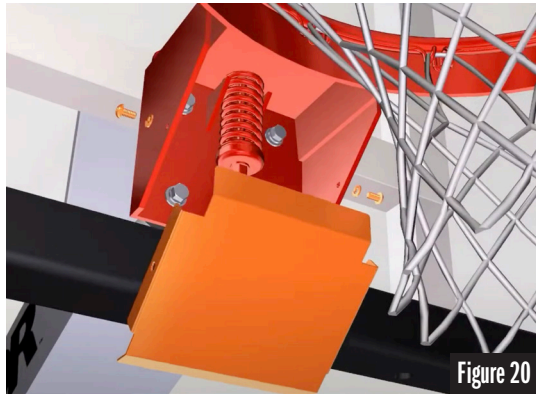

Figure 20

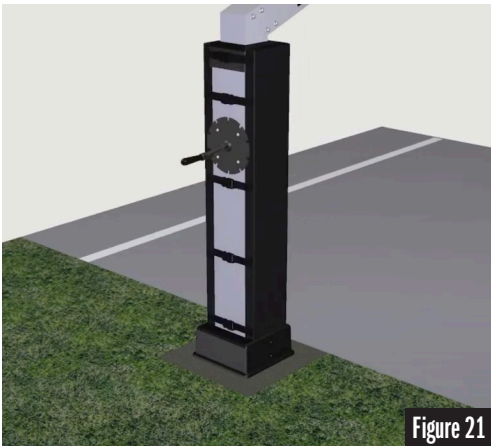

Figure 21

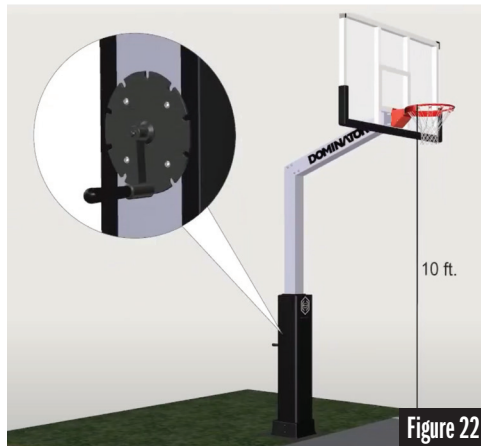

Figure 22

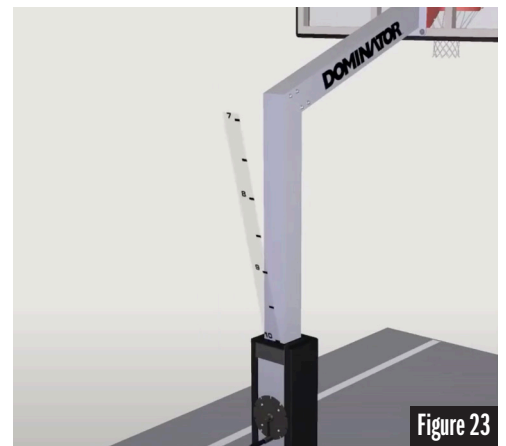

Figure 23

**STEP 13:** Attach and secure crank handle (Part J). Replace the Base Pole Pad. See Figure 21. Raise the hoop to 10 Feet with the crank handle. Check the height using a measuring tape. See Figure 22. Ensure crank handle locks into place to prevent unintended movement.

**STEP 14:** Add the Height Guide Decal (Part G) to the pole on the crank side with the 10' mark lined up with the top of the black joint cover. See Figure 23.

**STEP 15:** Lower the hoop to your desired playing height. Ensure crank handle locks into place to prevent unintended movement. Enjoy!

# SECTION 5: WARRANTIES & POLICIES

## DOMINATOR<sup>®</sup>

### BASKETBALL STANDARD LIMITED LIFETIME WARRANTY

Subject to the limitations set forth below, HomeSports (the “Manufacturer”) warrants to the original consumer purchaser (the “Purchaser”) of the Dominator Basketball Standard (hereinafter referred to as the “Dominator”) that the Dominator shall be free from material defects in parts and/or workmanship that impair the use of the Dominator for so long as the Purchaser owns the Dominator.

1. This Warranty is non-transferable and is expressly limited to the repair or replacement of a defective Dominator, including any part thereof, covered under this Warranty.
2. To make a claim under this Warranty, the Purchaser must first write the Manufacturer at 930 W 410 N, Suite 100, Lindon, UT 84042, to receive a Return Authorization number and/or determine specific needs.
3. The Manufacturer reserves the right to examine photographs and/or physical evidence of a Dominator claimed to be defective and to recover said Dominator pursuant to the terms of this Warranty, prior to authorization of a claim under this Warranty
4. Unless indicated otherwise by the Manufacturer, in order to determine whether a requested repair is covered under this Warranty, the Dominator must be shipped prepaid to the Manufacturer with a copy of the relevant proof of purchase. The Manufacturer will not be responsible for any loss or damage incurred in connection with the return of a Dominator or its parts to Manufacturer under this Warranty. The manufacturer will examine the Dominator so shipped and, in its sole and reasonable discretion, will determine (1) whether this Warranty covers the Dominator and, if it does, (2) whether the Dominator needs to be repaired or replaced. Any and all dealer service charges, labor costs, shipping costs, insurance, travel expenses and any other charges or costs involved in the removal, installation or replacement of a defective Dominator, including, but not limited to, any part thereof, covered under this Warranty, will be the sole responsibility of the Purchaser and must be prepaid. Any Dominator, including any part thereof, shipped to the Manufacturer “collect” will be refused.
5. THIS WARRANTY IS VOID IF THE DOMINATOR HAS BEEN DAMAGED BY ACCIDENT, UNREASONABLE USE AND/OR ABUSE, NEGLIGENCE, IMPROPER SERVICE, IMPROPER INSTALLATION OR HANDLING, FAILURE TO FOLLOW PROVIDED INSTRUCTIONS (INCLUDING WITHOUT LIMITATION USING THE DOMINATOR AT PROHIBITED HEIGHT LEVELS), SHIPPING, VANDALISM, ACTS OF GOD, ENVIRONMENTAL FACTORS, ALTERATION OF THE DOMINATOR, OR ANY OTHER EVENTS BEYOND THE CONTROL OF THE MANUFACTURER OR OTHER CAUSES NOT ARISING OUT OF DEFECTS IN MATERIAL OR WORKMANSHIP.
6. USING THE DOMINATOR FOR OTHER THAN RESIDENTIAL BASKETBALL USE WILL ALSO VOID THIS WARRANTY.
7. HANGING FROM THE NET OR RIM WILL ALSO VOID THIS WARRANTY: Rims are not warranted for any defects other than workmanship. Torn back plates, damaged springs, bent rings, damaged eyebolts and torn or distorted rim supports result from hanging on the rim are not warranted.
8. THIS WARRANTY DOES NOT COVER SCRATCHING OR SCUFFING OF THE DOMINATOR THAT MAY RESULT FROM NORMAL USAGE. THIS WARRANTY ALSO DOES NOT COVER RUSTING PARTS, FADING PAINT, CRACKS THAT DO NOT AFFECT THE FUNCTIONALITY OF THE PRODUCT, OR OTHER DAMAGE CAUSED BY WEATHER OR CLIMATE CONDITIONS OR EXPOSURE TO CORROSIVES SUCH AS SALTS, PESTICIDES, ET
9. This warranty gives the Purchaser specific legal rights, and such Purchaser may also have other rights which vary from state to state.
10. THIS WARRANTY IS GIVEN EXPRESSLY IN LIEU OF ALL OTHER EXPRESS WARRANTIES. ANY IMPLIED WARRANTY ARISING OUT OF THE SALE OF THE DOMINATOR, INCLUDING, BUT NOT LIMITED TO, THE IMPLIED WARRANTIES OF MERCHANTABILITY AND FITNESS FOR A PARTICULAR PURPOSE, IS LIMITED IN DURATION TO THE DURATION OF THIS WARRANTY.
11. Some states do not allow limitations on how long an implied warranty lasts, so the above limitation may not apply to certain Purchasers.
12. THE REMEDY OF REPAIR OR REPLACEMENT STATED ABOVE SHALL BE THE PURCHASER'S EXCLUSIVE REMEDY. THE MANUFACTURER DOES NOT ASSUME OR AUTHORIZE ANY PERSON OR REPRESENTATIVE TO ASSUME ON ITS BEHALF ANY OTHER LIABILITY IN CONNECTION WITH THE SALE OF A DOMINATOR. THE MANUFACTURER SHALL NOT BE LIABLE FOR (A) ANY DAMAGES OR EXPENSES THAT MAY OCCUR, INCLUDING, BUT NOT LIMITED TO, INCIDENTAL, SPECIAL OR CONSEQUENTIAL DAMAGES, ARISING OUT OF OR IN CONNECTION WITH THE DELIVERY, INSTALLATION, USE, PERFORMANCE AND/OR REMOVAL OF THE DOMINATOR (INCLUDING, BUT NOT LIMITED TO, DAMAGE TO CONCRETE OR THE PURCHASER'S YARD); (B) ANY OTHER CLAIM ARISING FROM NEGLIGENCE, STRICT LIABILITY, OR BREACH OF CONTRACT REGARDING THE DOMINATOR; OR © OTHER DAMAGES WITH RESPECT TO ANY ECONOMIC LOSS, LOSS OF PROPERTY, LOSS OF ENJOYMENT OF USE, COSTS OF INSTALLATION AND/OR REMOVAL, OR OTHER CONSEQUENTIAL DAMAGES FOR BREACH OF ANY EXPRESS OR IMPLIED WARRANTY COVERING THE DOMINATOR.
13. Some states do not allow the exclusion or limitation of incidental or consequential damages, so the above limitation or exclusion may not apply to certain Purchasers.
14. While the Manufacturer has made attempts to ensure that the Dominator is safe to use, freedom from injury cannot be guaranteed. The Purchaser assumes all risk of injury resulting from the use of the Dominator. All Dominators are sold subject to this condition, and no representative of the Manufacturer may waive or change this policy.



# DOMINATOR®

## BASKETBALL STANDARD SHIPPING POLICY

This Return Policy applies to the purchase of the Dominator® Basketball Standard (hereinafter referred to as the “Dominator”) by the original consumer purchaser (“you” or the “Purchaser”) from Leap Innovations (the “Manufacturer”).

1. Any offer for free shipping by the Manufacturer applies ONLY to shipments within the domestic 48 continental United States. Please contact us at 1-877-705-6556 for a shipping quote for deliveries to Alaska, Hawaii, Canada, Mexico, or other locations outside of the United States.
2. If the shipping address is changed during shipping, additional charges may apply.
3. Shipping dates are approximate and Manufacturer does not guarantee estimated delivery dates. Manufacturer is not liable under any circumstances for any delay in shipment or delivery.
4. The shipping carrier's appointment clerk should call you to set up a time for delivery. Time of delivery is usually between 8:00am and 5:00pm Monday through Friday, but delivery may occur outside of those hours depending on other factors.
5. The Dominator is shipped for “Curbside Delivery” and does not include set up or assembly of the Dominator. Shipping includes removing the order from the truck and depositing it at your curbside or in your driveway. Any additional requests you make of the deliverer may result in additional charges, which will be billed to you.
6. It is your responsibility to verify the delivery for correctness. You should confirm the correct number of boxes has been delivered to you. The Dominator 72 XL and 60 XL has 3 boxes and will come on 1 pallet.
7. You should also carefully inspect all items (especially the glass backboard) prior to signing for the delivery for damage during transit and take photographs of the damage.
8. If there is any damage to the Dominator, YOU MUST NOTE THE DAMAGE ON THE DELIVERY RECEIPT. The carrier, not the Manufacturer, is liable for damage to the Dominator during transit. If you sign the delivery receipt without noting the damage, you thereby release the carrier of all liability.
9. A signature is required for all deliveries. You will be required to sign a delivery receipt and delivery will not occur without it.
10. DO NOT REFUSE DELIVERY IF THE DOMINATOR, OR ANY PORTION THEREOF, IS DAMAGED. Simply note the damage on the delivery receipt and contact us at 801-768-4663 to receive a replacement part.
11. If a certain part, such as the glass backboard, is damaged, you may still keep and install the additional working parts while the replacement part is being delivered.
12. Please note, if you live down a road or driveway that the delivery truck cannot traverse, the delivery will not be completed. You may be required to pick up the order from the nearest carrier terminal.
13. Any order returned to Manufacturer marked undeliverable or similar is subject to a 15% restocking fee and any shipping charges incurred by Manufacturer for the initial shipment to the Purchaser will be charged to the Purchaser.

# DOMINATOR®

## BASKETBALL STANDARD RETURN POLICY

This Return Policy applies to the purchase of the Dominator® Basketball Standard (hereinafter referred to as the “Dominator”) by the original consumer purchaser (“you” or the “Purchaser”) from Leap Innovations (the “Manufacturer”).

1. The Purchaser may cancel an order before shipment and receive a full refund of the amount paid. Orders are normally shipped within 48 business hours and are sometimes shipped the same day.
2. The Purchaser may return an order within 7 days of receipt of the Dominator by the Purchaser to receive a partial refund. All returns are subject to a 15% re-stocking fee. The Purchaser is responsible for initial shipping fees upon return of the Dominator and any offer for free shipping is surrendered upon return. Except as provided in
3. Manufacturer's limited lifetime warranty, Manufacturer has sole discretion to reject a request for cancellation or return.
4. The Dominator must be unused, in the original shipping boxes and packaging, to be eligible for a refund.
5. Notwithstanding the above paragraphs, Purchaser shall have no right to cancel or return custom-made products.
6. To make a return, the Purchaser must first contact the Manufacturer at 1-877-705-6556 to receive a Return Authorization number and/or determine specific needs. YOU MUST HAVE A RETURN AUTHORIZATION NUMBER OR YOUR RETURN WILL NOT BE PROCESSED.
7. The Purchaser must ship the Dominator to the Manufacturer with proof of purchase. Any and all dealer service charges, labor costs, shipping costs, insurance, travel expenses and any other charges or costs involved in the return of a Dominator, will be the sole responsibility of the Purchaser and must be prepaid. The Manufacturer will not be responsible for any loss or damage incurred in connection with the return of a Dominator or its parts to Manufacturer. Any Dominator, including any part thereof, shipped to the Manufacturer “collect” will be refused.